

HD-01 Horizontal 3X6 Carport Installation Manual

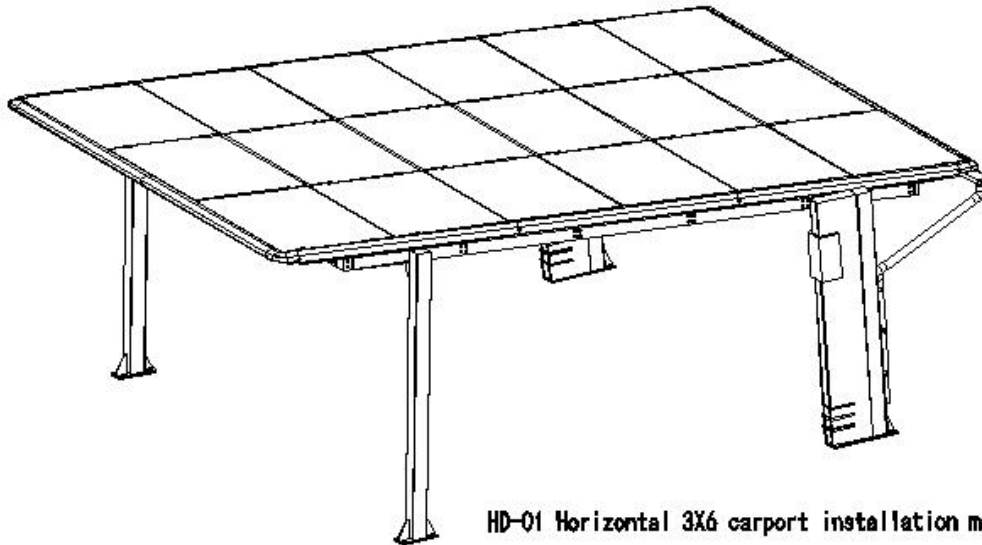

HD-01 Horizontal 3X6 carport installation manual

Preparing work before the installation

Confirmation of the relative distance dimensions of the site foundation bolts (Please strictly follow the construction drawings for foundation embedding)

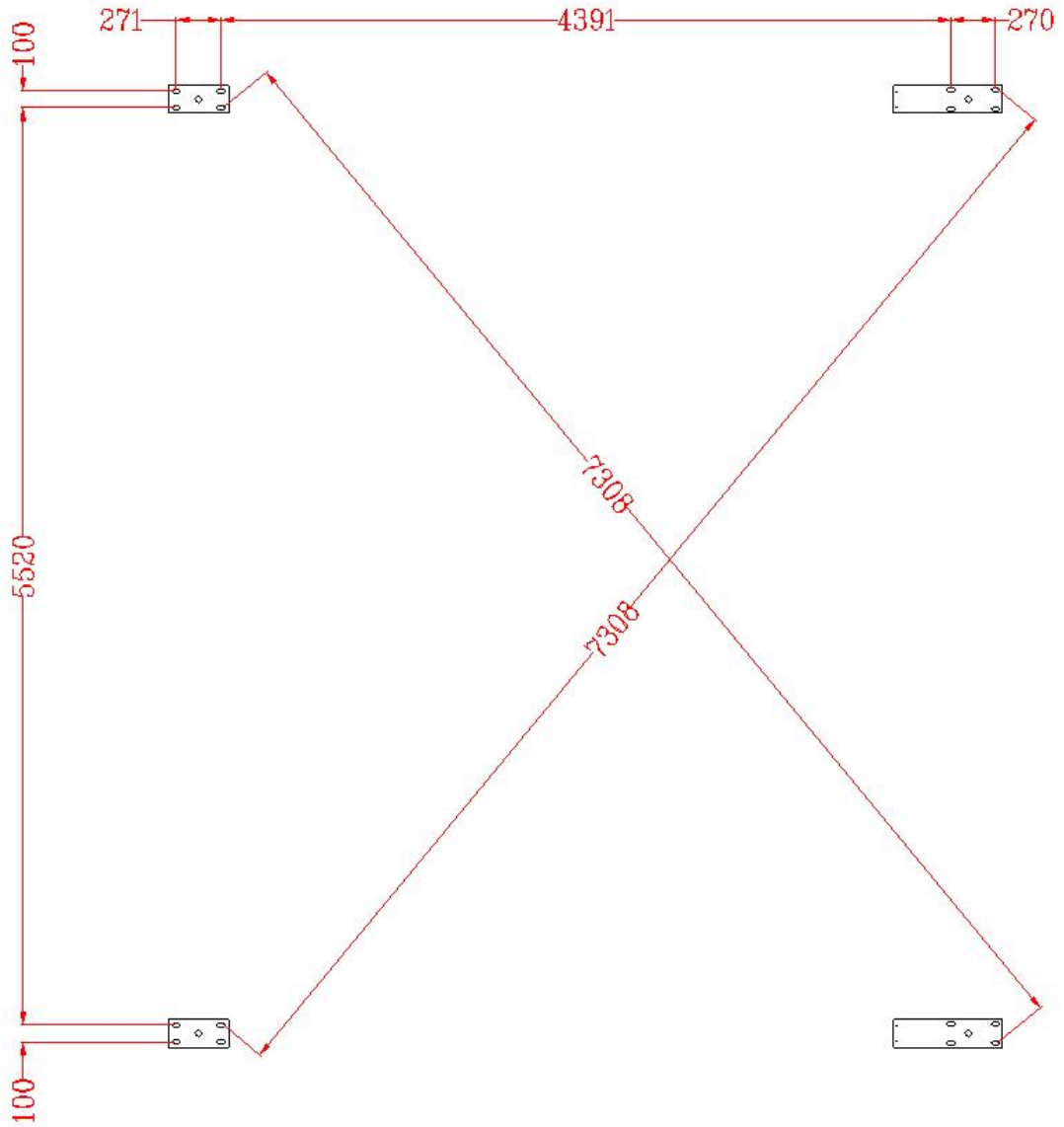









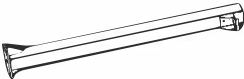

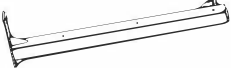
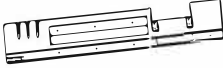
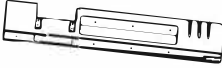
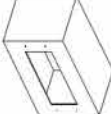



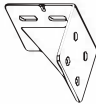







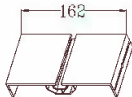
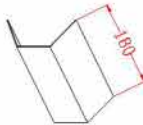

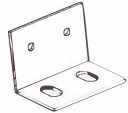

Check the relative dimensions of the anchor bolts before installation, the difference between the two dimensions of the diagonal size should be controlled within 10mm.

Prepare a $\phi 5.0$ drill, when the efficiency of self-tapping nails is low, you can drill the bottom hole with a drill bit before hitting the self-tapping nails.

Confirm the quantity of the parts that need to be installed.

- (1) Confirm the qty of all the parts.

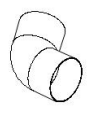
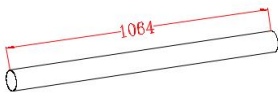
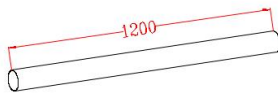
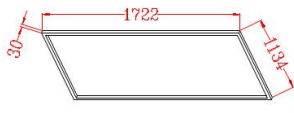
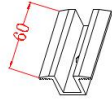
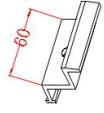
 <p>front column-L 1pc/set</p>	 <p>front column-R 1pc/set</p>	 <p>back column-L 1pc/set</p>
 <p>back column-R 1pc/set</p>	 <p>back column decoration frame-L 1pc/set</p>	 <p>back column decoration frame-R 1pc/set</p>
 <p>back column decoration frame lamp cover 2pcs/set</p>	 <p>beam 2pcs/set</p>	 <p>purlin2 4pcs/set</p>
 <p>purlin 2pcs/set</p>	 <p>purlin bracket 12pcs/set</p>	 <p>front decoration side board 4pcs/set</p>
 <p>front decoration side board 2 6pcs/set</p>	 <p>side decoration side board 6pcs/set</p>	 <p>arc fillet edge 4pcs/set</p>
 <p>sub-channel 15pcs/set</p>	 <p>side main channel 4pcs/set</p>	 <p>mid main channel 4pcs/set</p>
 <p>connected buckle for clamp 48pcs/set</p>	 <p>main channel connecting parts 8pcs/set</p>	 <p>front fascia 1pc/set</p>
 <p>gutter lift 6pcs/set</p>	 <p>gutter fastening hoop 6pcs/set</p>	 <p>gutter fastening parts 6pcs/set</p>
 <p>gutter 1pc/set</p>	 <p>gutter2 1pc/set</p>	 <p>gutter sealing cover 2pcs/set</p>

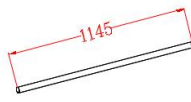
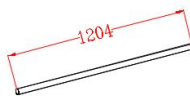
 gutter clip connector 1pc/set	 drainer 1pc/set	 holding bracket 3pcs/set
 65° curving part 2pcs/set	 draining pipe 1pc/set	 draining pipe 1pc/set
 PV modules 18pcs/set	 mid clamp 3 24pcs/set	 30 edge clamp1 24pcs/set
 drawbar M12 4pcs/set	 bushing 2pcs/set	 bushing2 2pcs/set

(2) Confirm the accessories.

UK Double Parking Household Carport - BOM List-HD-01-3X6							
Nc	Descriptions	Specification	Material	Qty	Unit	Length (mm)	Remarks
30	Neutral silicone structural adhesive	/	/	1	PC	/	
31	drawbar	M12	Q235B	4	PC	1380	HDG average 65 um
32	sleeve tube	φ 33.5X2.0	Q235B	2	PC	1145	HDG average 65 um
33	sleeve tube2	φ 33.5X2.0	Q235B	2	PC	1203	HDG average 65 um
34	Holding bracket selftapping nails	ST6.3x19	SUS410	3	set	0	with white pad
35	Gutter riveting parts	4x13Core pull rivets (coffee)	aluminum	16	set	0	coffee color
36	Pipe clamp screws	M5X15 cross pan	galvanize	3	set	0	
37	Edgy clamp bolt	M8x20Allen	SUS304	24	set	0	with 1 spring pad
38	Mid clamp bolt	M8x25Allen	SUS304	24	set	0	with 1 spring pad
39	Bolt for side decoration frame and column	M6x20Allen	8.8 class HDG	10	set	0	with 1 spring pad
40	Diagonal beams and purlin supporting boards bolt	M12x150 Hexagons	8.8 class HDG	48	set	0	With 2 felt pads, 1 spring pad, and 1 nut
41	Diagonal beams and column supporting boards bolt	M12x150 Hexagons	8.8 class HDG	8	set	0	With 2 felt pads, 1 spring pad, and 1 nut
42	Gutter ornament bolt	M12x30 Hexagons	8.8 class HDG	36	set	0	With 2 felt pads, 1 spring pad, and 1 nut
43	Bolt for purlin and purlin supporting board	M12x30 Hexagons	8.8 class HDG	48	set	0	With 2 felt pads, 1 spring pad, and 1 nut
44	Bolt for front fascia and purlin	M12x30 Hexagons	8.8 class HDG	12	set	0	With 2 felt pads, 1 spring pad, and 1 nut
45	Tie rod matching nut	M12	8.8 class HDG	8	set	0	with 1 large flat pad and 1 spring pad
46	Lamp cover bolt	M4x15 cross pan	galvanize	8	set	0	
47	Connecting selftapping screw for channel and purlin	ST6.3x19	SUS410	48	set	0	with white pad
48	Connecting selftapping screw for channel and channel connector	ST6.3x19	SUS410	48	set	0	with white pad
49	Selftapping screw for clamp connecting	ST6.3x19	SUS410	192	set	0	with white pad
50	Selftapping screws for external binding	ST6.3x19	SUS410	56	set	0	
51	Front fascia, gutter ornament selftapping screw	ST6.3x19	SUS410	40	set	0	

Installation process.

First install the four front and back columns and install the diagonal beams on both sides (note that the diagonal beams have front and rear directions), pre-install the screws and nuts, do not need to tighten.

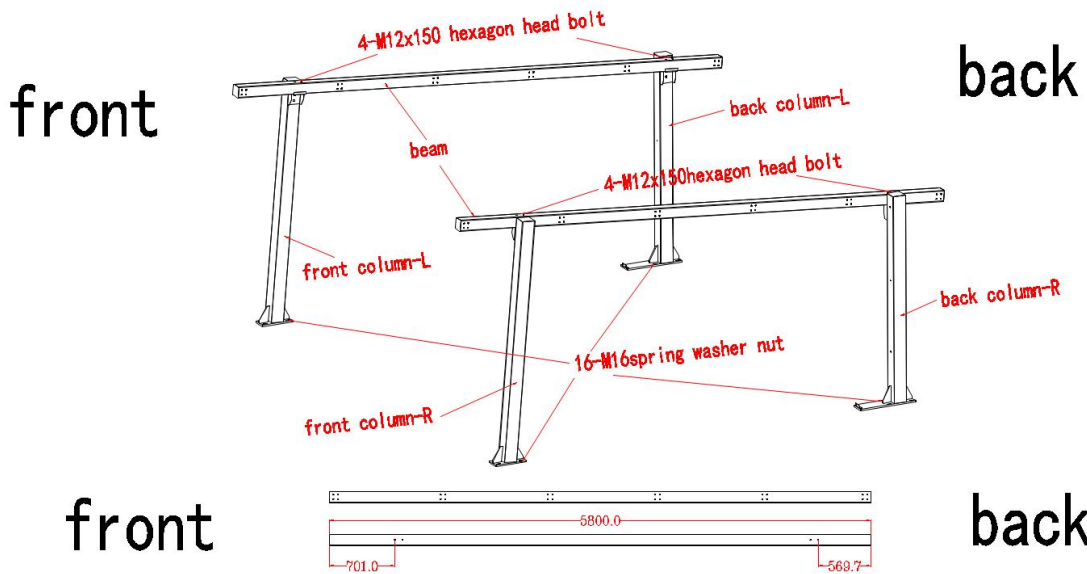

1. Install purlin bracket at both ends of the 6 purlins, pay attention to distinguish the specifications of the purlins and the direction of the opening, after that tighten all the bolts.

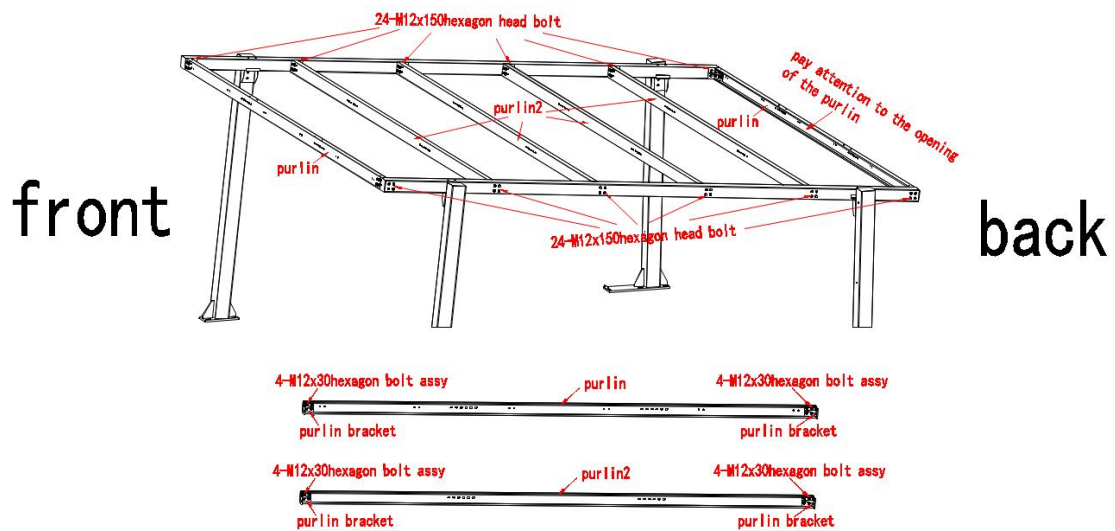

2. Install the rod and sleeve tube as below (put the rod inside the sleeve tube)

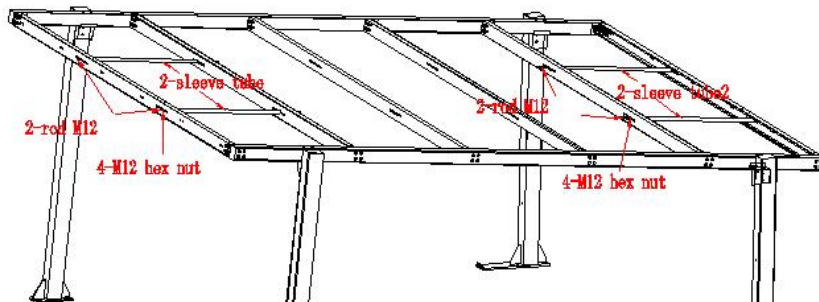

3. Install the side main-channel and mid main-channel firstly, put the self-tapping nails on the clamp connecting clip as per dimensions. When install the main-channel connecting part, should put glue first then the self-tapping screws.

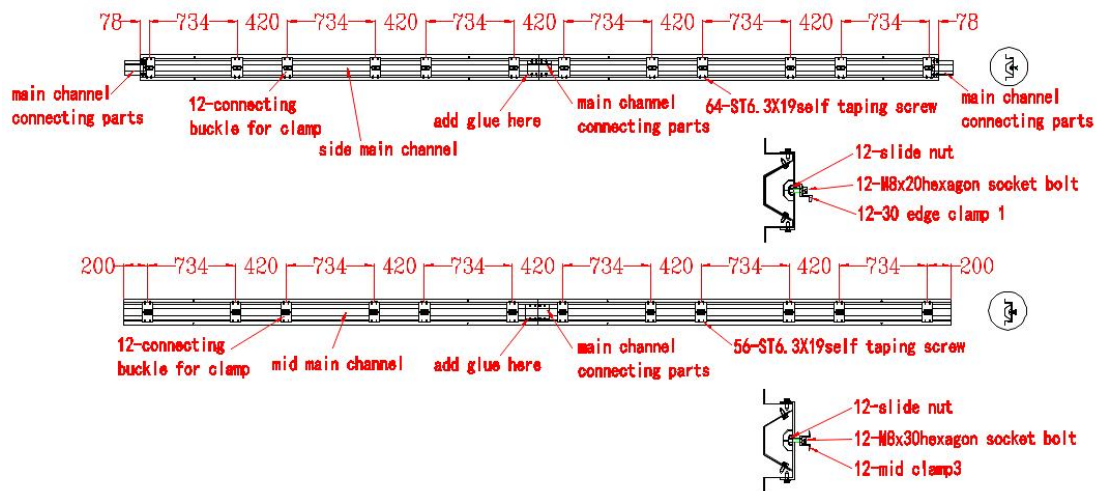

4. Install the channel assy, fix the channel by the holes at the two ends with self-tapping screws first, then put on self-tapping screws on every part on the purlin.

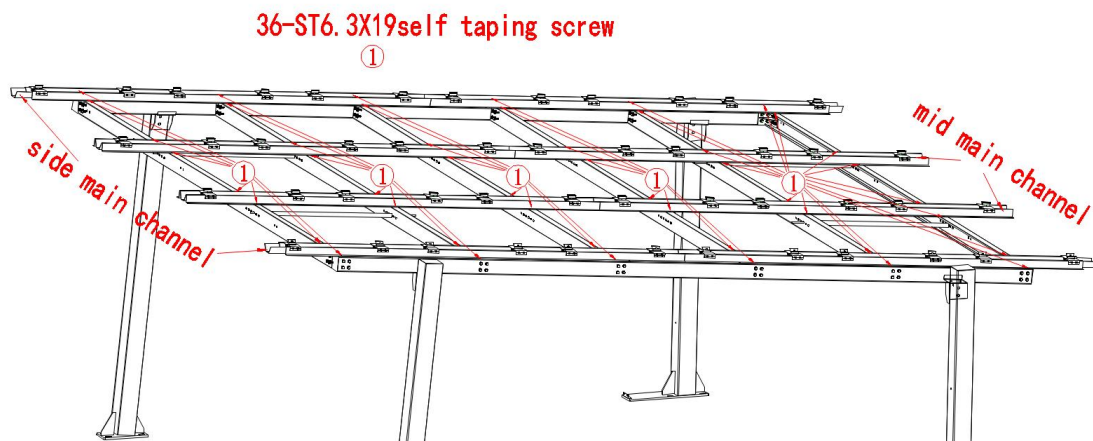

5. Install the front facia and gutter ornament, do not tighten the screws, prepare for the installation of the gutter.

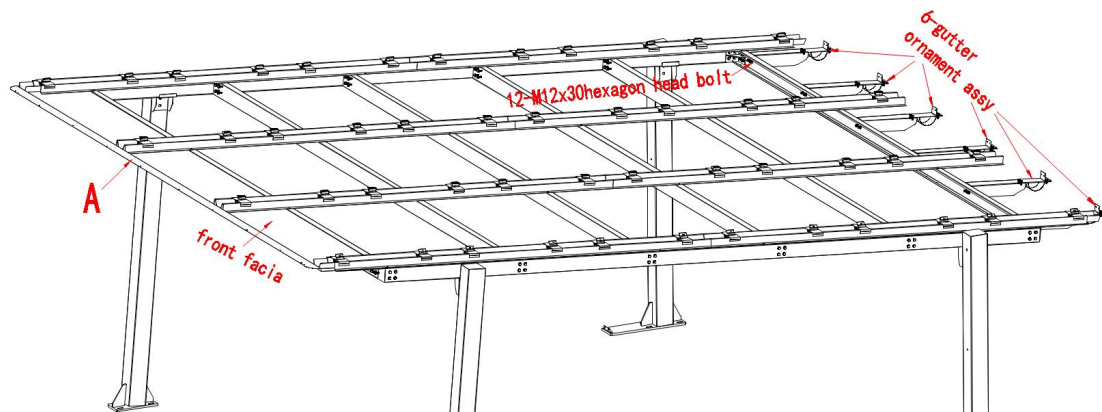



A-A

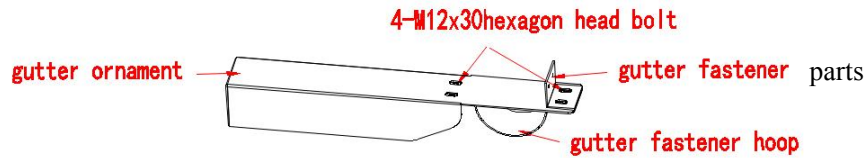

gutter ornament

6. Connect the cables for the lamp and then lead it to the decoration frame and fix it, install the back column decoration frame on the back column, connect the cable with the AC power, finally add glue on the lamp box and the decoration frame on the back column.

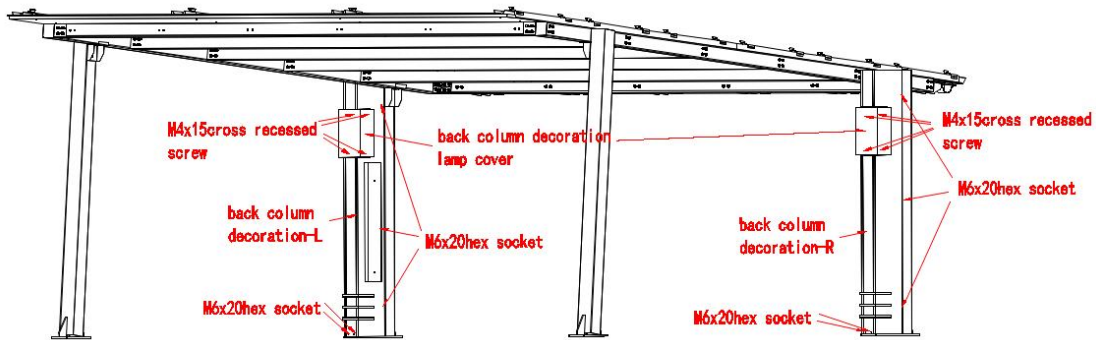

7. First, install the gutter, gutter2, gutter sealing cover, gutter clip connector, drainer together, then the gutter ornament. Next, put together draining pipe 1064mm, draining pipe 1200mm, 65° bending, connect the drainer. All the connecting parts need add glue. Nail the holding bracket on the column.

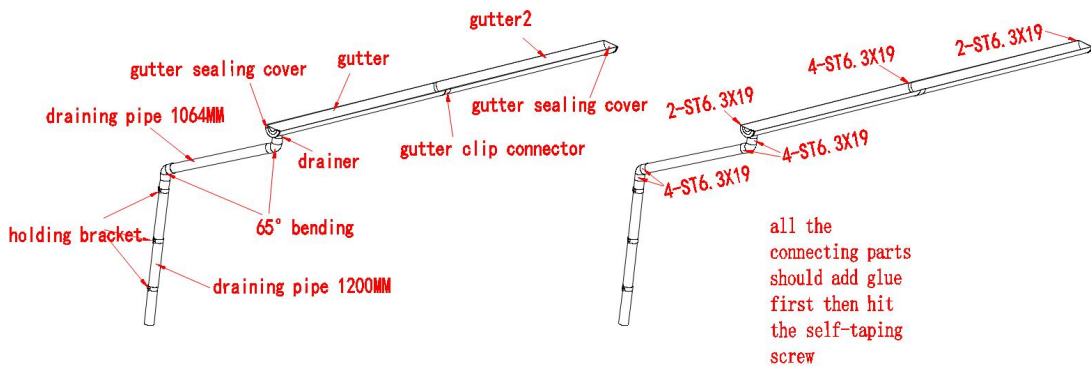

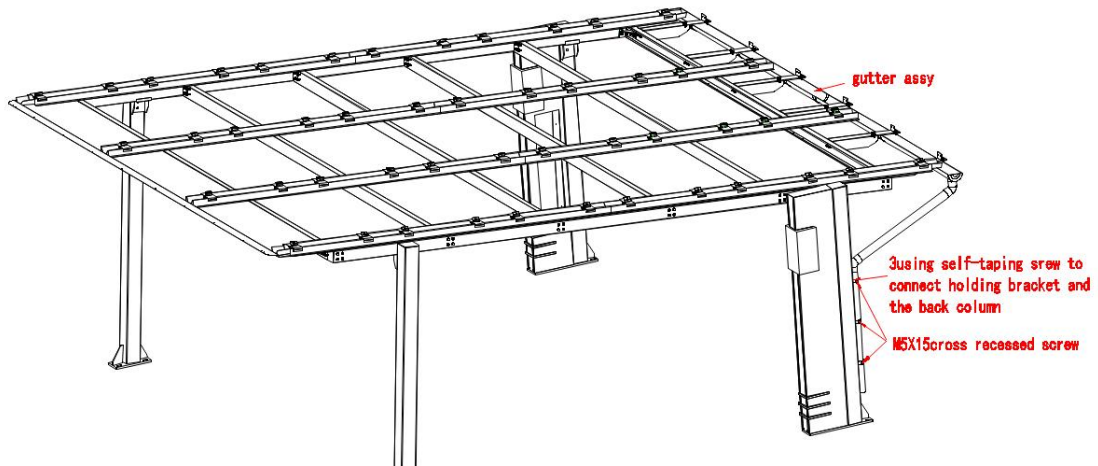

8. Install the PV modules (pay attention to put the sub-channel between the modules and the main channel), tighten them all.

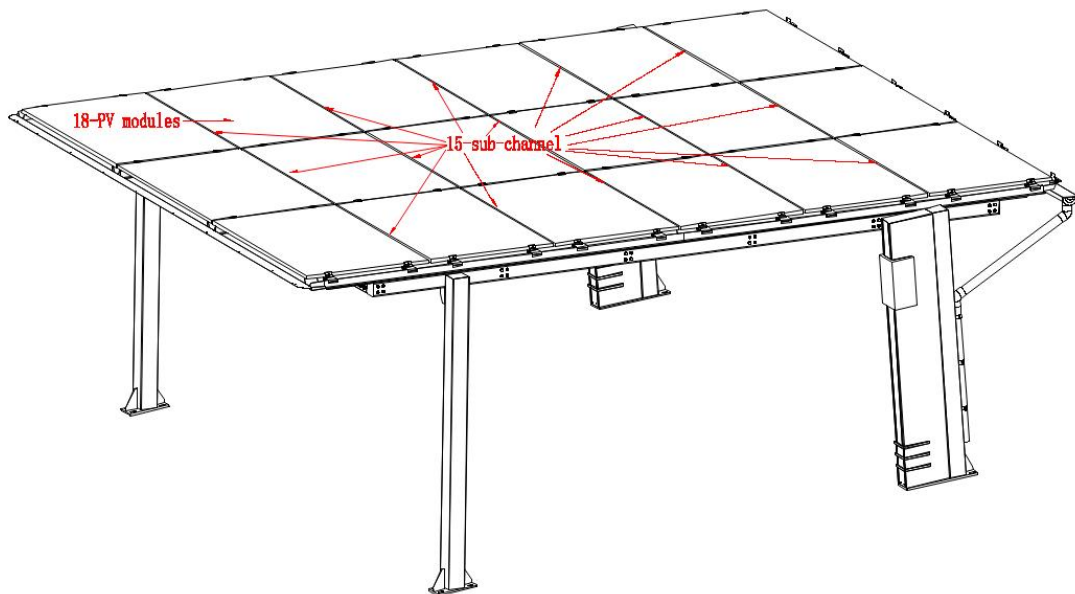

9. Install the front decoration boards² for the two sides of binding with self-taping screws. Nail the front fascia of the front and back columns, then the gutter ornament.

